

HP-ENERGY STAR 7 Series Windows



Your Partner For Factory-Direct Windows & Doors

Manufactured By

RJT industries
manufacturer of windows and doors for over 40 years



earthwise
WINDOWS & DOORS

Featuring The Best Warranty In The Industry

Our HP-ENERGY STAR 7 Series Windows are designed to provide the ultimate strength while giving homeowners aesthetic quality, energy efficiency and security. Earthwise Brand Windows are built to last and engineered to provide excellent thermal performance for as long as you own your home.

Limited lifetime coverage on:

Accidental glass breakage

Seal failure

All hardware

Vinyl frame & sash components

Coverage is:

Fully transferable

Non-prorated

Warranty:

backed by
40 years of
quality window
manufacturing



Unlimited Styles

Whether trying to preserve a certain architectural look or create a dramatic statement, we offer a multitude of combinations utilizing styles, shapes and sizes that can fit your needs.

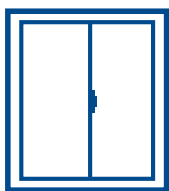

Slider



Double Hung

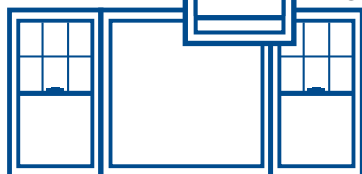

Quarter/Half/Quarter



Casement

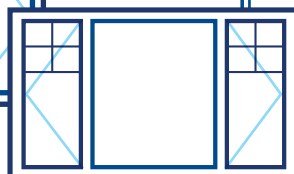

Quarter/Half/Quarter



Picture



Trapezoid

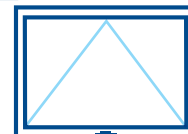

Awning

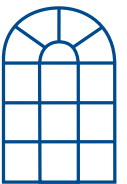

Palladium

Architectural Design

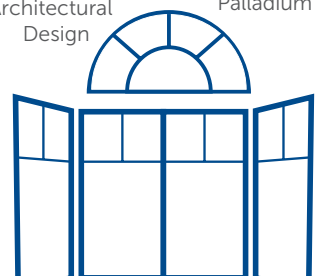

Bay, Bow, & Garden

Our Windows Guarantee Efficiency And Strength

You can trust our team to make sure every small detail is covered. Quality features you should expect from a great window as well as superior design elements make our windows a permanent solution. And, with all of these attributes, the need for service is virtually eliminated.

HP-ENERGY STAR 7 Features:

Heavy-walled construction

Builds in more durability.

Secure Vent Latch

Allows for ventilation with added security deterrent benefits.

Fusion-Welded Frame & Sash

Provides strength, durability, and perfectly square windows that are air tight.

Balance Covers

Further reduce air infiltration while providing a crafted, finish.

Dual Tilt-In Sashes

Sashes tilt in for easy cleaning due to safety tilt hardware.

Interlocking Meeting Rail

Integral interlock provides additional security and draft-sealing efficiencies.

Equal Glass Sizes

Provides traditional architecture look with superior structural integrity.

Sunshield® PVC Chemistry

Specially formulated by Deceuninck to perform well in extreme weather conditions.

Strong One-piece Sloped Sill

Multi-cavity sloped sill has no snap-on parts and provides positive water runoff, even in driving rain.

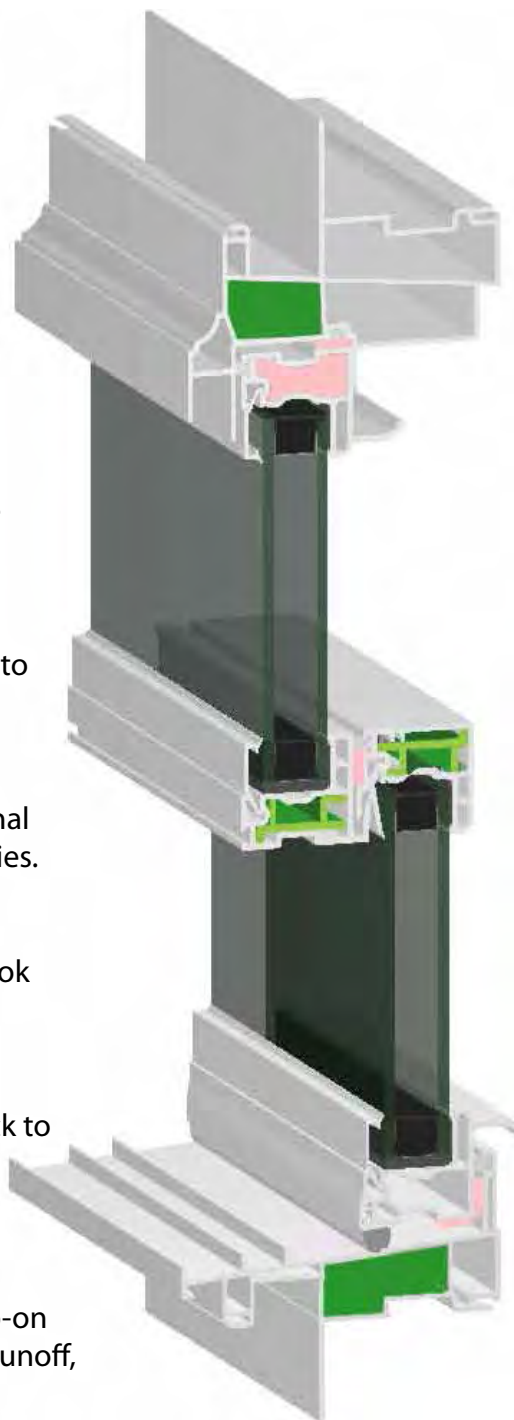

Foam Filled Frames

Provides thermal performance

Weatherstripping Technology

The only window system that stops drafts and filters out air particles like germs, mold spores, dust and pollen.

Merv 13 measured similar to furnace filter. *Patent Pending*

Dual Action Swing Lock System

Offers superior security deterrent.

Superspacer Optimized Glass

Guaranteed not to fail utilizing Super Spacer Glass.

Innergy® Thermal Reinforcement

In meeting rail provides metal like stiffness without the thermal conductivity.

Insulated Double Low-E Glass with Argon

U value = .24

Stainless Steel Constant Force Balance

Trouble-free, and maintenance free while providing smooth operation as well as safe and easy cleaning.

Extruded Half Screen

Stronger frame is less likely to bend like roll form material.



The Power of Options

Make your home as unique as you are, with customizable window options. From colors to finishes, to handles and more, you have the power to choose from endless features. Take a look at what we have to offer!

GRILL OPTIONS

RJT provides a range of exterior options and capabilities to make your windows a beautiful feature of your home.

SCREEN OPTIONS

Half screen • Full screen

GLASS OPTIONS

Tempered • Obscured • Tinted •

INTERIOR GRILLES & DIVIDERS



Flat



Contour

SOLID INTERIOR COLORS



Linen White

LAMINATE COLORS



Midnight Black



Chocolate Brown

Colonial Grid Patterns

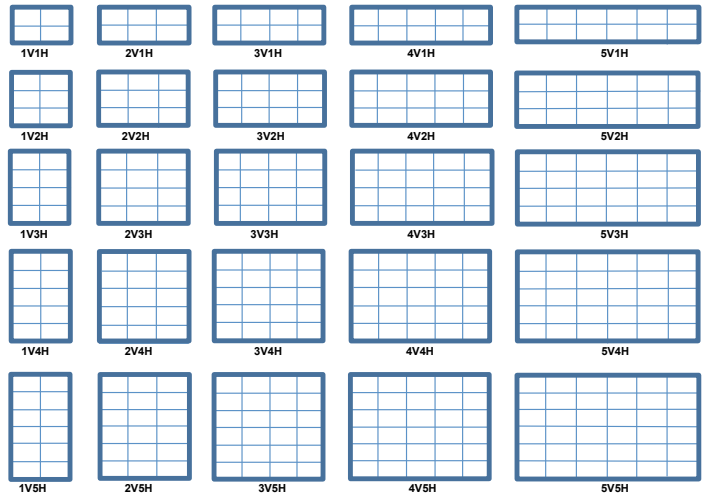

EXTERIOR COLORS

TruBond polyurethane color coating • Can be mixed or matched to your desired color.



Adobe Cream



Terratone



Vintage Wicker



Tuscan Clay



Architectural Bronze



Musket Brown



English Red



Forest Green



Castle Gray



Dark Charcoal



Harbor Blue



Mystic Blue

Attention to detail ensures you a long-term investment, high performance, beauty and security.

Congratulations for choosing RJT Industries.

Earthwise Windows is a national network of locally-owned window manufacturers.

Acadian Windows
Destrehan, LA

Earthwise of Kansas City
Kansas City, MO

Home Guard Industries
Grabill, IN

Synergy Windows
Sherman, TX

Advanced Window Products
Salt Lake City, UT

Eastern Architectural
Systems
Fort Myers, FL

Mercury Excelum
East Windsor, CT

U.S. Energy Windows
North Las Vegas, NV

D&W Windows
Davison, MI

Energy Shield Window
& Door
Phoenix, AZ

RJT Industries
Woodbridge, VA

Western Window
Nampa, ID

Dasan Glass and Windows
Vernon, CA

Sprouse Windows
New Martinsville, WV

Manufactured By

RJT industries
manufacturer of windows and doors for over 40 years



Corporate Offices & Factory Location
14893 Persistence Drive
Woodbridge, Virginia 22191
703-643-1510